

# DPM SERIES

Models: DPM-52, DPM-47, DPM-40, DPM-36, DPM-32

# DUR-A-LIFT®



DPM-47DU PICTURED

## SPECIFICATIONS

	DPM-52	DPM-47	DPM-40	DPM-36	DPM-32*
WORKING HEIGHT	57'	52'	45'	41'	37'
SIDE REACH (MH, DU, DP)	31'6"	31'6"	31'6"	27'6"	25'4"
APPROX. STOWED TRAVEL HEIGHT	11'8"	10'5"	10'6"	10'6"	10'8"
HEIGHT TO BOTTOM OF PLATFORM	52'	47'	40'	36'	32'
BASKET CAPACITY (MH, DU WITH JIB)	400#	400#	400#	400#	400#
BASKET CAPACITY NOT USING JIB (DU)	550#	550#	550#	550#	550#
BASKET CAPACITY (DP)	600#	600#	600#	600#	600#
APPROX. LIFT WEIGHT	4400#	4300#	3900#	3700#	3300#
ARTICULATING ARM TRAVEL	0° to 75°	0° to 75°	0° to 75°	0° to 75°	-
MAIN BOOM TRAVEL	-30° to 75°	-30° to 75°	-30° to 75°	-30° to 75°	-15° to 80°
EXTENSION TRAVEL	120"	120"	120"	96"	120"

Dur-A-Lift Inc. reserves the right to improve models and change specifications without notice or obligation. Dur-A-Lift equipment meets or exceeds all applicable ANSI Standards as of the date of manufacture.

\*Telescopic aerial lift

- WORKING HEIGHT UP TO 57'; SIDE REACH TO 31'6"
- MATERIAL HANDLING OR DOUBLE-PERSON
- 180-DEGREE BASKET ROTATOR
- SIDE-MOUNTED JIB LIFTS UP TO 1000#
- INSULATED (DPM) OR NON-INSULATED (DPMs)
- 3 STANDARD BASKET CONFIGURATIONS



**MANY WAYS TO CUSTOMIZE!**

**DUR-A-LIFT®**  
**WE SPEAK BUCKET TRUCK**

# DPM SERIES

Models: DPM-52, DPM-47, DPM-40, DPM-36, DPM-32

## STANDARD

Proportional controls; lower override controls; engine start/stop from basket; basket access from ground; compensated upper boom; hydraulic basket leveling; continuous rotation; joystick and lockout controls

## BASKET CONFIGURATIONS

**MH BASKET:** Single-person, material handling; side-mounted jib and winch lifts up to 1000#; upper and lower winch control; 400# basket capacity; 24" X 30" fiberglass or aluminum basket; 180-degree basket rotator

**DP BASKET:** Double-person, personnel; 600# basket capacity; 24" X 48" fiberglass or aluminum basket; 180-degree basket rotator

**DU BASKET:** Dual configuration; double-person, personnel or single person, material handling; side-mounted jib and winch lifts up to 1000#; 550# basket capacity when not using winch; 400# basket capacity when using winch; 24" X 42" fiberglass or aluminum basket; 100° basket rotator

## OPTIONAL

High electrical resistant controls; outriggers; basket liner for fiberglass baskets; fiberglass main and articulating booms; tool circuits; D.C. backup system; 180° basket rotator (DU); aluminum basket; non-insulated version available (DPMS)

## INSULATED OR NON-INSULATED

Available in insulated (Cat. C or D) or non-insulated formats. Full pressure controls.

**Insulated:** DPM      **Non-insulated:** DPMS

## REACH DIAGRAM DPM-32

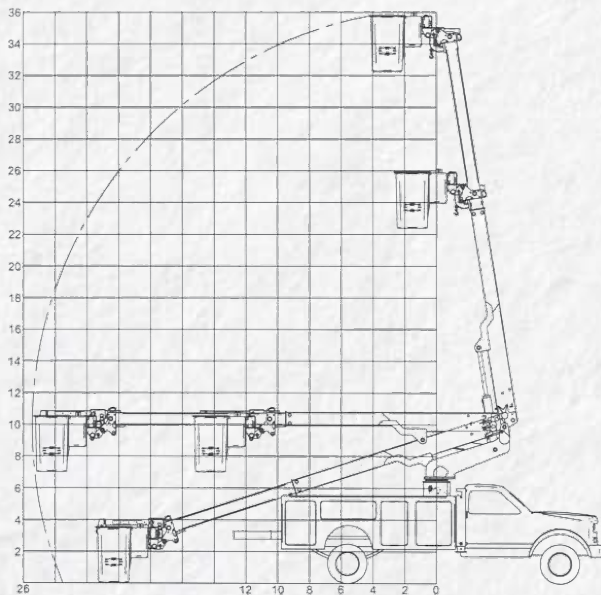

CHASSIS REQUIREMENT, MIN.: 19,000 GVWR  
CHASSIS CAB TO AXLE REQUIREMENT, MIN.: 84"

## BASKET OPTIONS:



**24" X 30"**  
MH: SINGLE-PERSON, MATERIAL HANDLING  
*Ask about the personnel version of the MH*



**24" X 42"**  
DU (DUAL CONFIGURATION)  
MATERIAL HANDLING OR PERSONNEL

Use it two ways. ↗



**BONUS BASKET:**  
Ask about the 36" X 60" extra large aluminum basket.

## REACH DIAGRAMS DPM-36, DPM-40

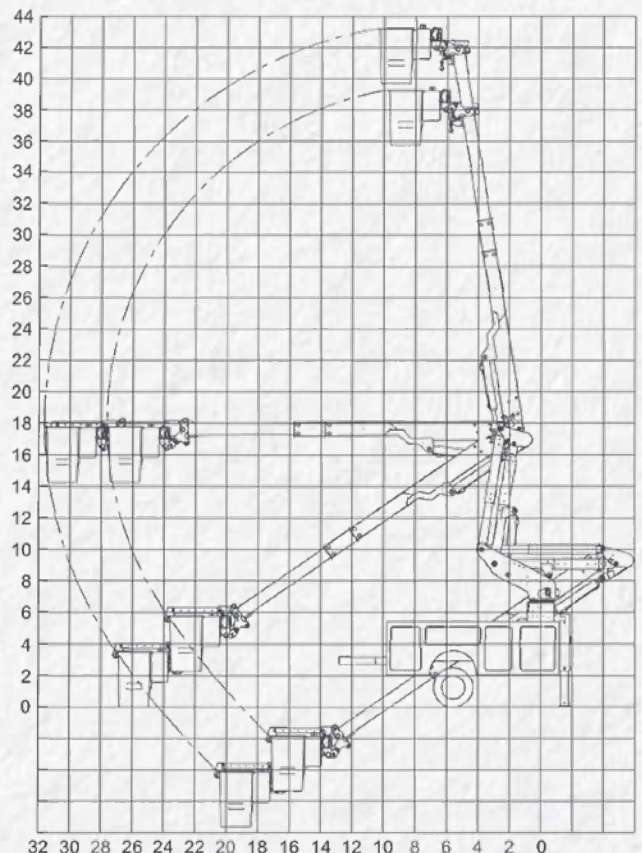

CHASSIS REQUIREMENT, MIN.: 19,500 GVWR  
CHASSIS CAB TO AXLE REQUIREMENT, MIN.: 60" (DPM-36); 84" (DPM-40)



**2"**  
 (DURATION):  
 DOUBLE-PERSON



**24" X 48"**  
 DP: DOUBLE-PERSON, PERSONNEL



*Fiberglass  
 and aluminum  
 options available in all  
 standard basket styles.*

The DPM's negative boom angle not only allows you to access the basket from ground level but also allows for convenient access to the storage compartments without leaving the basket. Conveniently positioned controls will allow the operator to be more effective when maneuvering their materials.



## REACH DIAGRAMS **DPM-47, DPM-52**

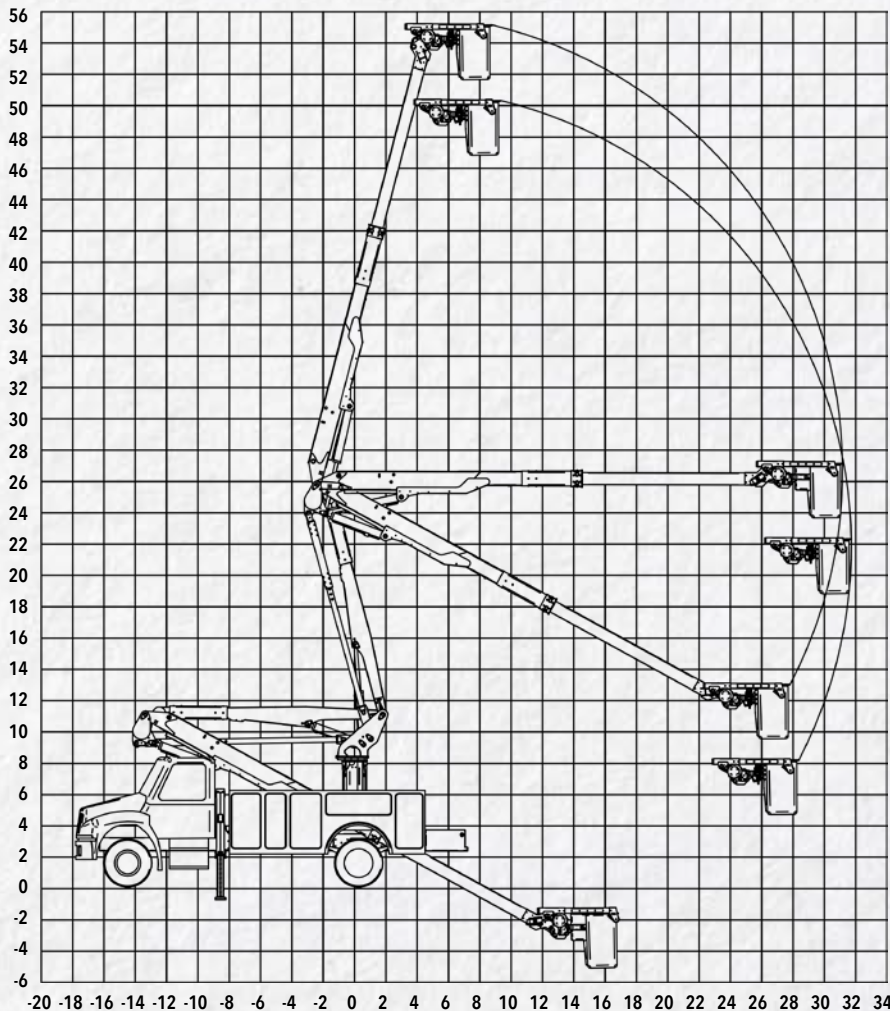

CHASSIS REQUIREMENT, MIN.: 19,500 GVWR (DPM-47); 22,000 GVWR (DPM-52)  
 CHASSIS CAB TO AXLE REQUIREMENT, MIN.: 84" (DPM-47); 94" (DPM-52)

## DPM MODELS

Dur-A-Lift's DPM series lift features five models that have max working heights that range from 37 to 57 feet. Models can be equipped with an MH, DU, or DP basket in fiberglass or aluminum.

### TELESCOPIC



**DPM-32DP** REACH UP TO 37'

### TELESCOPIC ARTICULATED



**DPMS-36DP** REACH UP TO 41'



**DPM-40MH** REACH UP TO 45'



**DPM-47DU** REACH UP TO 52'



**DPM-52DP** REACH UP TO 57'

**DUR-A-LIFT**  
 WE SPEAK BUCKET TRUCK

# DPM SERIES

Models: DPM-52, DPM-47, DPM-40, DPM-36, DPM-32

**DUR-A-LIFT**  
WE SPEAK BUCKET TRUCK



**BUILT FOR YOU;  
BUILT TO LAST.**  
Trust Dur-A-Lift for  
all of your bucket truck  
needs.  
[www.dur-a-lift.com](http://www.dur-a-lift.com)



Many great  
options for those in  
the electric utility  
and sign/lighting  
industries!



## DPM SERIES BUILDS

Build the perfect bucket truck for you and your needs.

Ask about available chassis, body, basket, tailshelf, and accessory options for the DPM series bucket truck.



READ MORE



740 Industrial Blvd, Bedford VA 24523  
1+ (540) 586-1021  
[www.AMPrents.com](http://www.AMPrents.com)